

HERINTREDE VAN VLOEISTOFKOELING IN HET DATACENTER



RONALD VAN VEEN
TECHNICAL SOLUTIONS ARCHITECT



FHI  IT INFRA



HET KENNISEVENT OVER COMPUTERRUIMTES, DATACENTERS EN CLOUD COMPUTING

2021
16 NOVEMBER

1931 Congrescentrum | 's-Hertogenbosch

Agenda

- Wat drijft de nieuwe belangstelling voor vloeistofkoeling in de datacenter omgeving?
- Verband tussen toepassingen en hoge energie dichtheid
- High Density IT-apparatuur en gevolgen voor het datacenter
- Overzicht vloeistofkoelingstechnologie
- Vloeistofkoeling - Marktomvang en groei
- Voorbereiding voor adoptie

Architects of

Continuity™



2021
16 NOVEMBER

WWW.FHI.NL/ITINFRA

Drijver achter de nieuwe belangstelling voor vloeistofkoeling

Eerst stapje terug.... Wet van behoud van Energie

Elektrisch verbruik van een server vertaald zich 100% naar warmte (ja, op de paar mW na die over netwerkkabels de server kan verlaten)

Voorbeeld: server neemt 1 kW op en geeft 1 kWth warmte af

De natuurwet geeft aan: energie kan niet verloren gaan maar alleen overgaan naar een andere vorm!

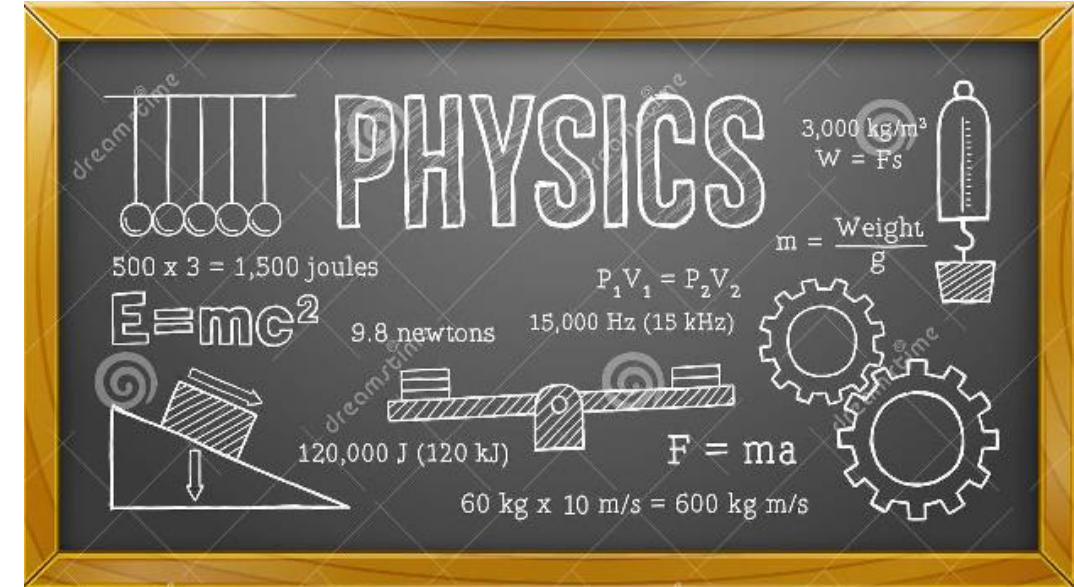

2021

16 NOVEMBER

WWW.FHI.NL/ITINFRA

Drijver achter de nieuwe belangstelling voor vloeistofkoeling

Maar servers worden toch steeds energie zuiniger?...

Dat klopt zeker, echter we hebben het dan over de verhouding energie verbruik versus rekenkracht (flops / Watt)

De vraag naar meer rekenkracht neem echter nog steeds toe waardoor het totale energie verbruik harder groeit dan ooit in datacenters



IoT (Internet of Things)



Media and Entertainment



Manufacturing – simulation and testing



Smart City



Data Infrastructure for Autonomous Vehicles



AI for Big Data



Healthcare



Finance-Trade automation Fraud detection



2021

16 NOVEMBER

WWW.FHI.NL/ITINFRA

Drijver achter de nieuwe belangstelling voor vloeistof koeling

Vloeistof koeling is toch niet nieuw ?...

Dat klopt zeker, er zijn al jaren servers en zelfs hele datacenters met vloeistof koeling. (OVH is goed voorbeeld)

De drijver hierachter is de kosten van koeling verlagen

Minder kosten willen we allemaal wel, dit is echter geen eenvoudige opgave, zeker niet in een Colo datacenter (gedeeld datacenter)
In Colo DC's is veel verschillende server hardware aanwezig.

Vloeistofkoeling kosten zijn hoog t.o.v. lucht koeling en terugverdienen op energie kosten is niet eenvoudig



Angst voor water bij apparatuur.



2021

16 NOVEMBER

WWW.FHI.NL/ITINFRA

Drijver achter de nieuwe belangstelling voor vloeistofkoeling

Nieuwe vraag naar vloeistof koeling

Door de nieuwe generatie Chips is er nu een technische noodzaak ontstaan

Trend is voor watts per processors is stijl omhoog

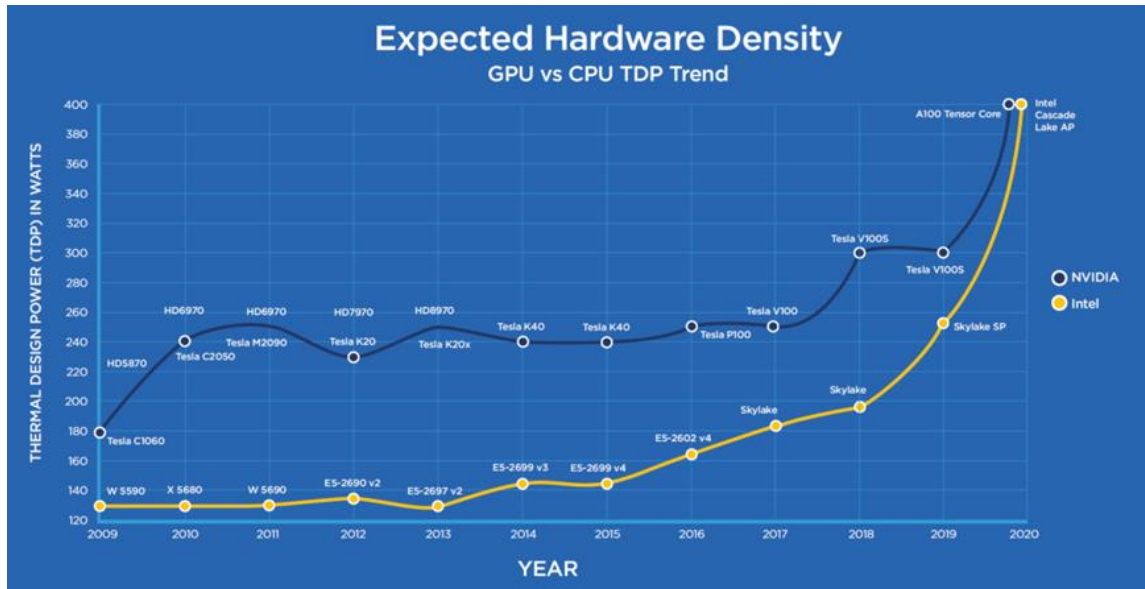

Market Drivers



High power Chips

CPU and GPU server components increasing in power resulting in higher Thermal Design Power beyond air cooling capability



Low Latency

Interdependency of components bringing them closer together = compaction of components making it difficult to cool with air



AI & HPC

Adoption beyond science labs. HPC going into mainstream adoption including cloud based HPC, Finance, Online Gaming, Media & Entertainment



Environment/Efficiency

Reduced power consumption eliminating fans and compressors. No Noise



Harsh environments

Sealed systems deployed in uncontrolled environments without airflow



2021

16 NOVEMBER

WWW.FHI.NL/ITINFRA

High Density IT-apparatuur en gevolgen voor het datacenter

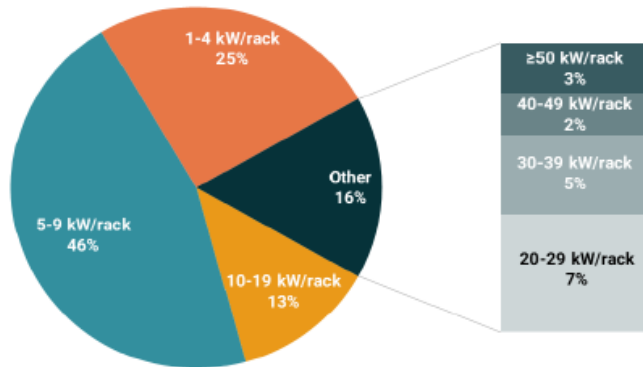
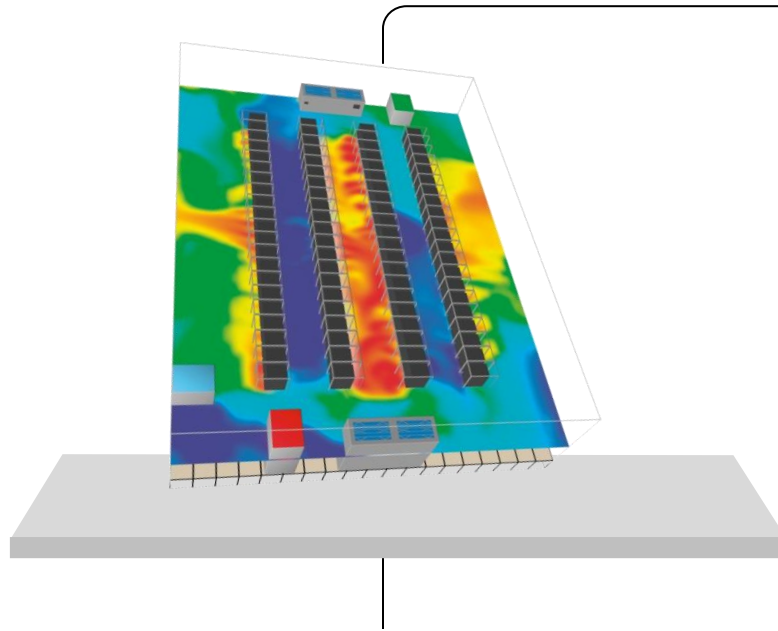

What is the MOST COMMON (modal average) server rack density deployed in your organization's data center(s)?

Choose one.*

*All figures rounded

Source: Uptime Institute Global Survey of IT and Data Center Managers 2020, n=422

UptimeInstitute | INTELLIGENCE



Challenges

- Airflow beheren met dynamische belastingen (Hot Spots)
- Verlaagde supply lucht temperatuur voor High Density IT-apparatuur
- Hoge retour lucht temperatuur uit High Density IT-apparatuur
- Energie-efficiëntie en duurzaamheidsdoelen beheren



Solutions

- Koeling toepassen dichtbij de warmtebron
- Air flow management; containment, in-row, in-rack
- Direct to chip liquid cooling - cold plate
- Immersion cooling



2021

16 NOVEMBER

WWW.FHI.NL/ITINFRA

Overzicht vloeistofkoelingstechnologie

DATA CENTER LIQUID COOLING

INDIRECT LC

Rear Door HX

1-Phase

2-Phase

Cold Plate

1-Phase

2-Phase

DIRECT LC

Immersion

1-Phase

2-Phase



2021
16 NOVEMBER

WWW.FH.NL/ITINFRA

Overzicht vloeistofkoelingstechnologie

DATA CENTER LIQUID COOLING

INDIRECT LC

Rear Door HX

Cold Plate



DIRECT LC

Immersion



2021
16 NOVEMBER

Datacenter facility kant voor vloeistofkoeling

Gekoeld water vloeistof--vloeistof

Lucht koeling vloeistof--lucht

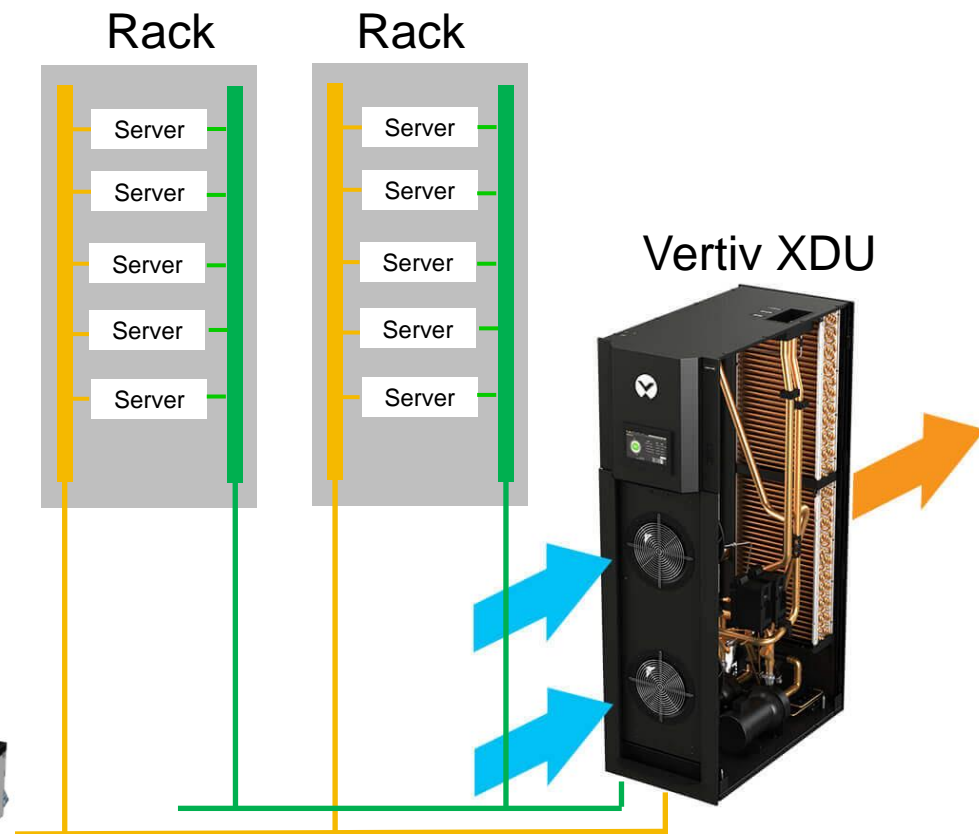
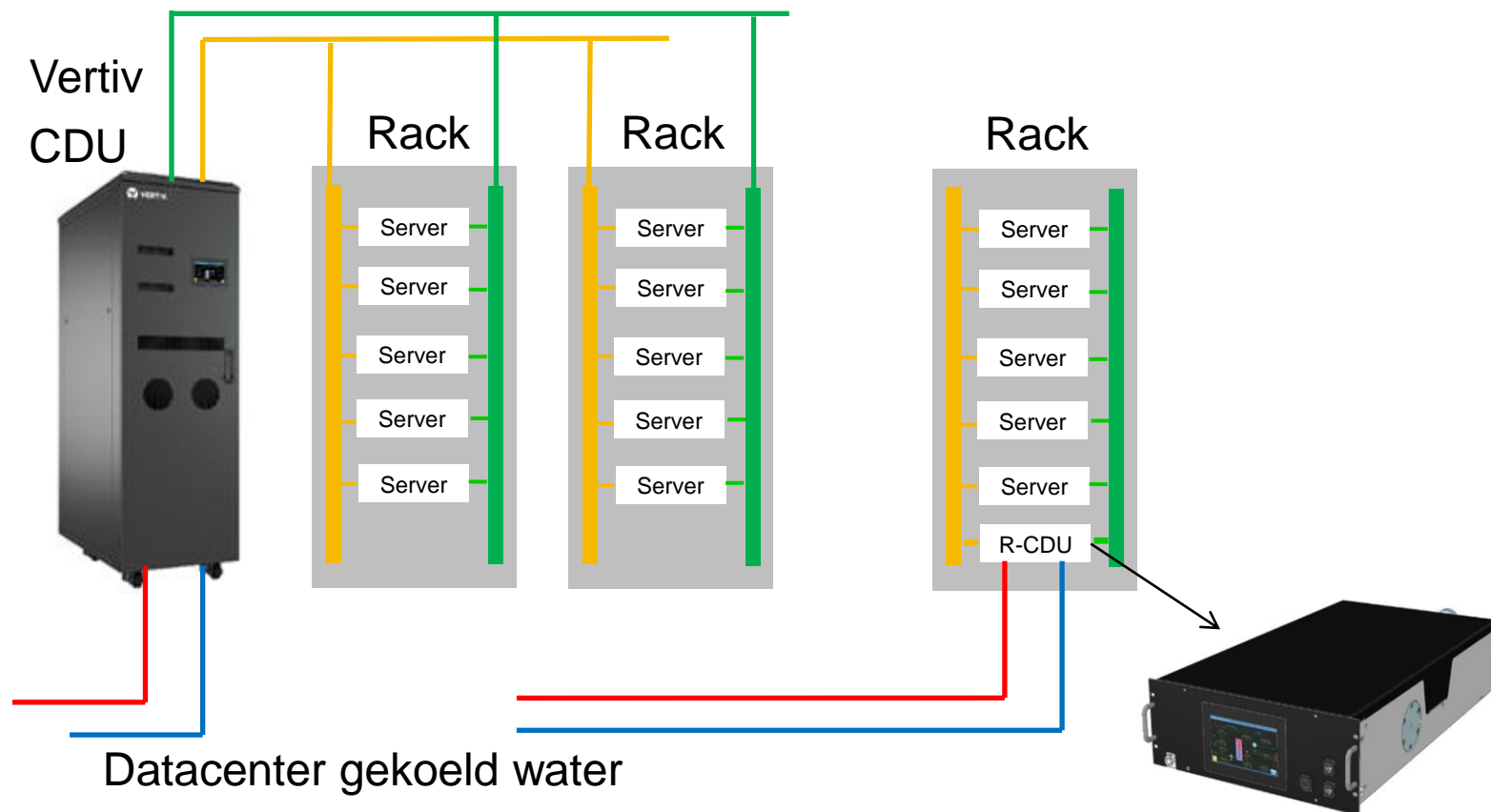

2021

16 NOVEMBER

WWW.FH.NL/ITINFRA

Vloeistofkoeling - Marktomvang en groei

Market Size & Growth

DATA CENTER LIQUID COOLING MARKET, BY REGION (USD BILLION)

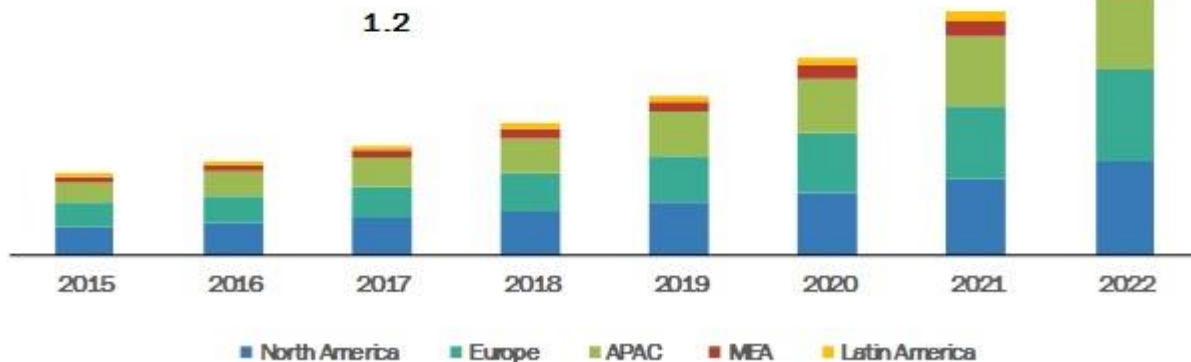

2020 Liquid Cooling Market

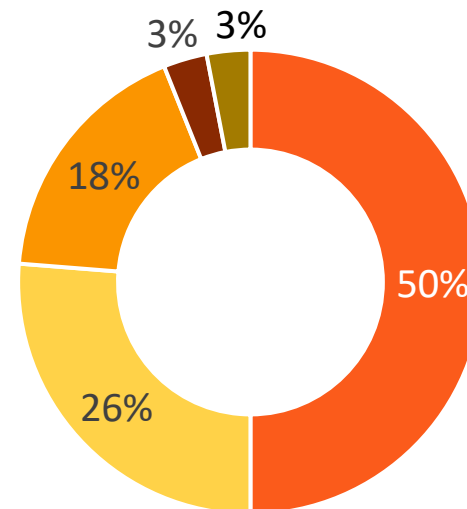

5 Year CAGR

Liquid Cooling 16-28%

- 1 P Direct to Chip
- 1P Immersion Tank
- 1P Immersion Chasis
- 2P Direct to Chip
- 2P Immersion Tank

- ✓ Major server OEMs offer SKUs supporting Direct to Chip Liquid Cooling
- ✓ Intel recently announced a focus on immersion cooling



2021
16 NOVEMBER

WWW.FH.I.NL/ITINFRA

Vloeistofkoelingstechnologieën - Voorbereiding voor adoptie

Strategieën voor effectief ontwerp, bouw, implementatie en onderhoud

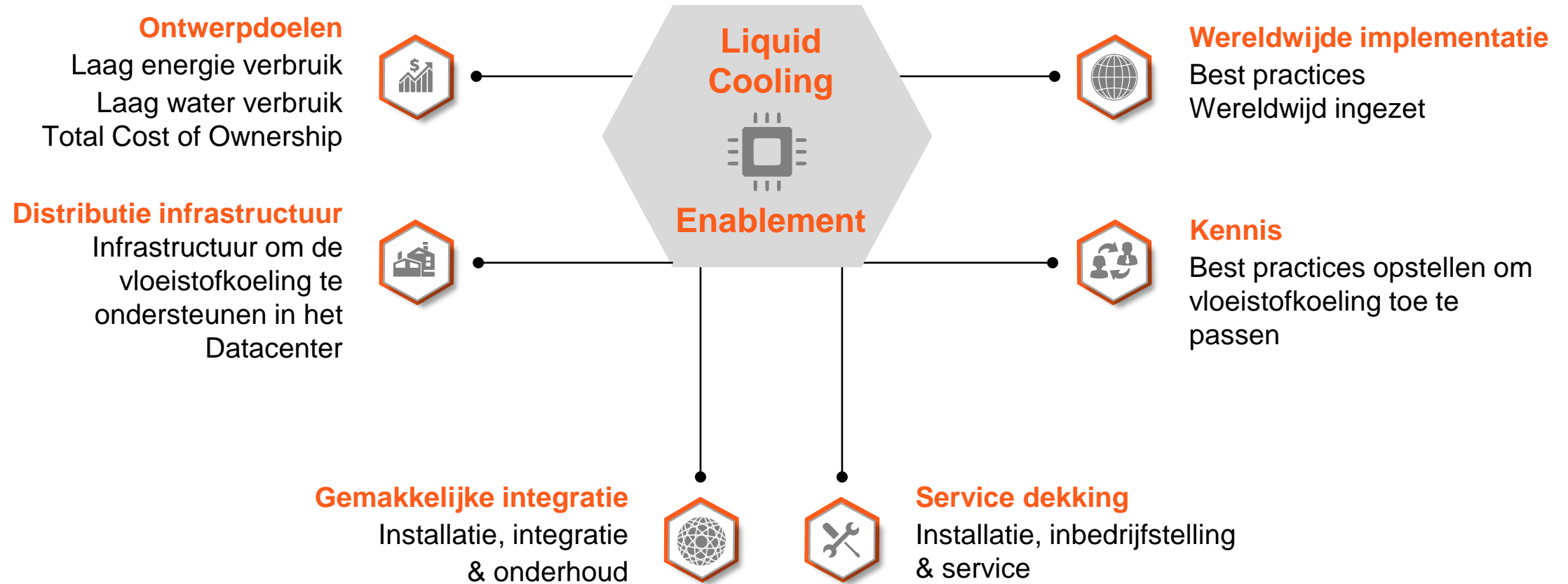

Mogelijkheid voor de industrie om vloeistofkoeling op grote schaal in te zetten en groei in high density te ondersteunen



2021

16 NOVEMBER

WWW.FHI.NL/ITINFRA

Sustainability in High Density



Sustainability Metrics

$$PUE: \frac{\text{Total Energy Consumption}}{\text{IT Energy Consumption}}$$

$$WUE: \frac{\text{Annual water use}}{\text{IT Energy Consumption}}$$

$$ERE: \frac{\text{Cooling} + \text{Power} + \text{Lighting} + \text{IT Reuse}}{\text{IT Energy Consumption}}$$

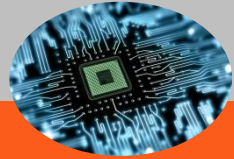

Direct to Chip

- Vermindering ventilatorvermogen
- Koeling bij de bron
- 70%+ warmte in vloeistof

- Hoogste vloeistoftemperaturen
- 100% vrije koeling met dry coolers in meeste klimaten
- Vermindering water gebruik

- Gebruik van retourwater op hoge temperatuur
- Voorverwarmen voor boiler of elektriciteitsvoorziening
 - Stads- of woningverwarming



Immersion

- Elimineert serverfans
- Koeling bij de bron
- 100% warmte in vloeistof

- Hoge vloeistoftemperaturen
- Verhoogde mogelijkheid voor vrije koeling
- Vermindering water gebruik



Bijkomende voordelen

- ✓ Verkleining van m2 gebruik (stroomverdeling)
- ✓ Minder behoefte aan cold aisle (Immersion)
- ✓ Gemakkelijker te beheren dynamic loads
- ✓ Ondersteuning voor high density applications
- ✓ Vermindering van energieverbruik
- ✓ Flexibel voor Edge en Modular Datacenters
- ✓ Meer vrije koeling (minder energie verbruik)
- ✓ Hogere potentie voor warmte hergebruik

Photo by Unknown Author is licensed under [CC BY-SA](https://creativecommons.org/licenses/by-sa/4.0/)



2021

16 NOVEMBER

www.fhi.nl/itinfra

Vertiv Covers the Complete Liquid Cooling Eco System

Covering the needs for Liquid Cooled IT

Coolant Distribution Unit

2

Centralized & Rack mounted CDU's to distribute and manage liquid to servers for Direct to Chip Cooling

Heat Rejection

1

Fluid Cooler & Chillers to reject heat outdoors

Indoor Chiller

3

Drop in Chiller to replace DSE units to leverage the efficiency of the Vertiv EconoPhase technology and Flexibility to move from air to liquid using existing infrastructure

Immersion

4

Immersion Racks to support server compaction and IT that can no longer be cooled with air or direct to chip

Key components

- ✓ **Coolant Distribution Units**
(maintain liquid integrity)
- ✓ **Heat Rejection**
(Operate in high ambient temperatures)
- ✓ **Liquid Loop**
(Secondary loop to rack and cold plate)



2021

16 NOVEMBER

WWW.FH.NL/ITINFRA



FHI  IT INFRA



HET KENNISEVENT OVER COMPUTERRUIMTES, DATACENTERS EN CLOUD COMPUTING



2021
16 NOVEMBER

1931 Congrescentrum | 's-Hertogenbosch