



DeltaProto
Maart 2024

Knutselen voor Professionals

Michiel Wanninkhof

**D&E
EVENT**

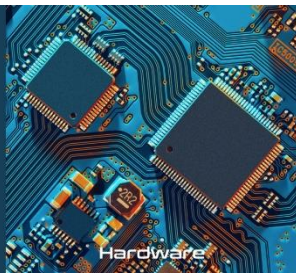

Hardware



Software



Test & Measurement



Engineering



Research & Development

Het ontwerpen van
innovatieve elektronica

Woensdag 20 maart 2024
1931 Congrescentrum 's-Hertogenbosch



Knutselen voor Professionals



D&E
EVENT

Het ontwerpen van innovatieve elektronica

Woensdag 20 maart 2024
1931 Congressentrum 's-Hertogenbosch



Knutselen voor Professionals

D&E
EVENT
Het ontwerpen van innovatieve elektronica

Woensdag 20 maart 2024
1931 Congressentrum 's-Hertogenbosch

MIL-DTL-117 – Mil Spec Bags & Detail Specification

MIL-DTL-117H Mil Spec Bags

All of our **bags** and **tubing** for the following materials meet the MIL-DTL-117 Specifications listed in the excerpt (below the material and bag size tables) from the official [MIL-DTL-117](#) detail specification from the US Department of Defense. Please note, [MIL-DTL-117](#) used to be [MIL-B-117](#), prior to 2001 when the US Department of Defense made a sweeping change.

Bags and Tubing Certified to [MIL-DTL-117H](#)

(formerly MIL-B-117) Specifications:

Material	Material Mil Spec	Bag/Construction Mil Spec
Protect PK #1	Mil-PRF-121 Grade A Type I Class 1	MIL-DTL-117 Type II Class C Style 1
Protect PK #18	Mil-PRF-121 Grade A Type II Class 1	MIL-DTL-117 Type III Class C Style 1
Protect 470	Mil-PRF-131 Type I Class 1	MIL-DTL-117 Type I Class E Style 1
Protect KF	Mil-PRF-131 Type I Class 2	MIL-DTL-117 Type II Class E Style 1
Protect Scrim- B	Mil-PRF-131 Type I Class 3	MIL-DTL-117 Type IV Class E Style 1
Protect 1193	Mil-PRF-22191 Type I	MIL-DTL-117 Type I Class E Style 2

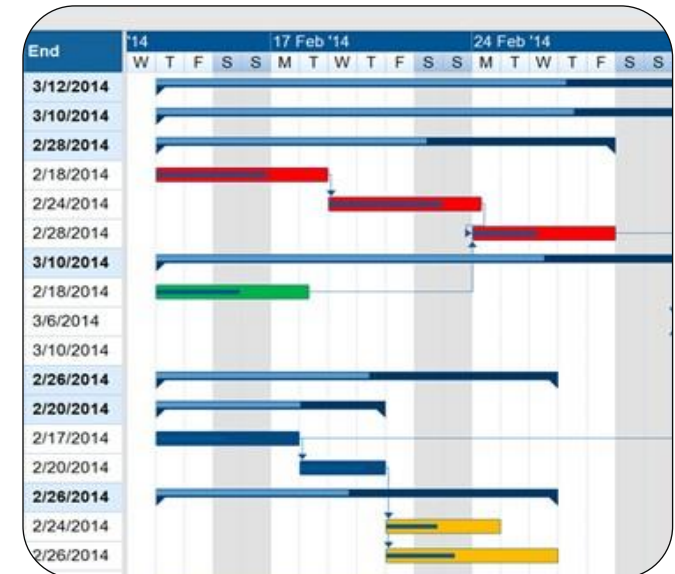
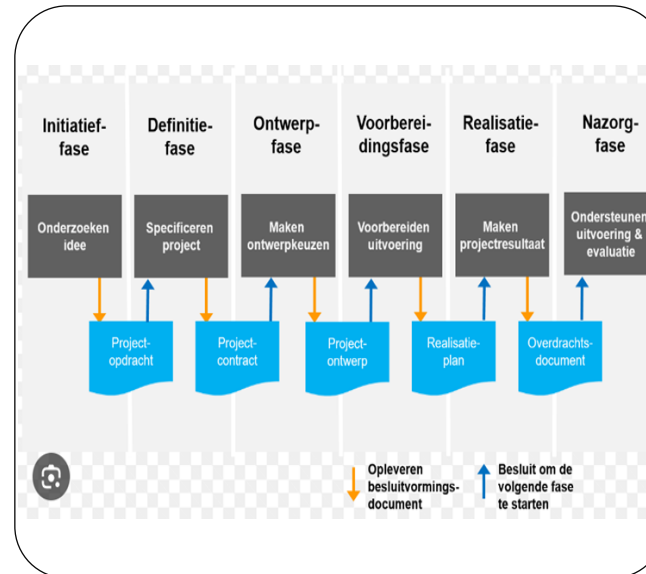

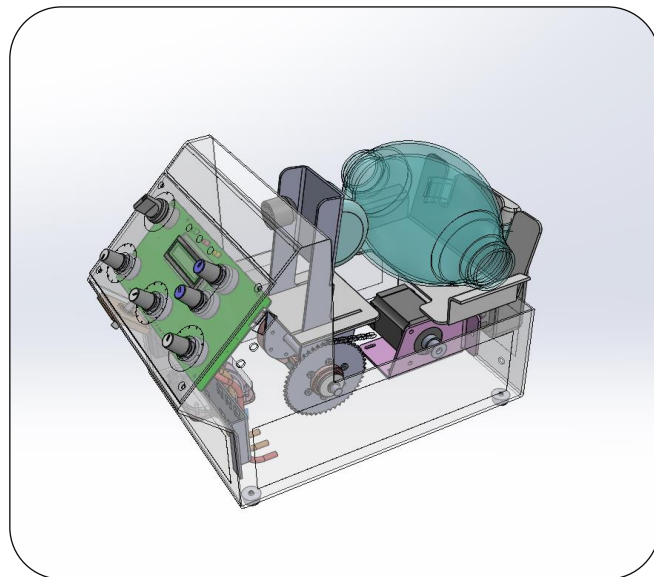

Knutselen voor Professionals



D&E
EVENT

Het ontwerpen van innovatieve elektronica

Woensdag 20 maart 2024
1931 Congressentrum 's-Hertogenbosch

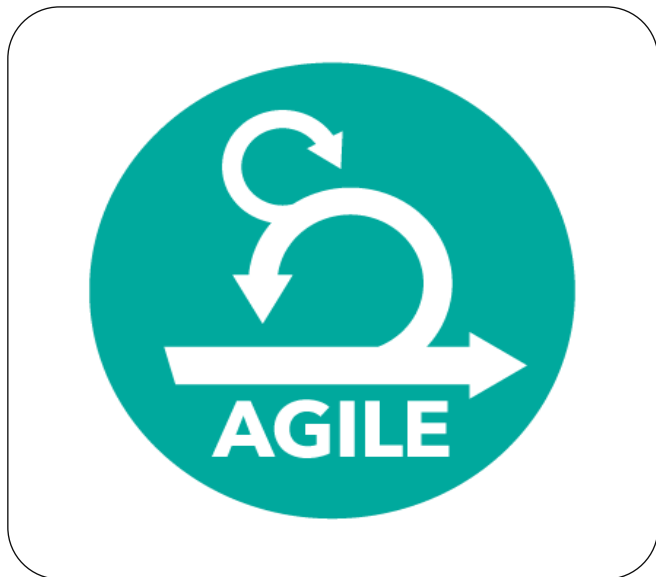

Knutselen voor Professionals

D&E
EVENT
Het ontwerpen van innovatieve elektronica

Woensdag 20 maart 2024
1931 Congrescentrum 's-Hertogenbosch

De 3 T's



Time



Tools



Team



Time

4-6

Project Cycles
4-6-... Month Cycles



Month Cycle
15 dagen denken
15 dagen doen

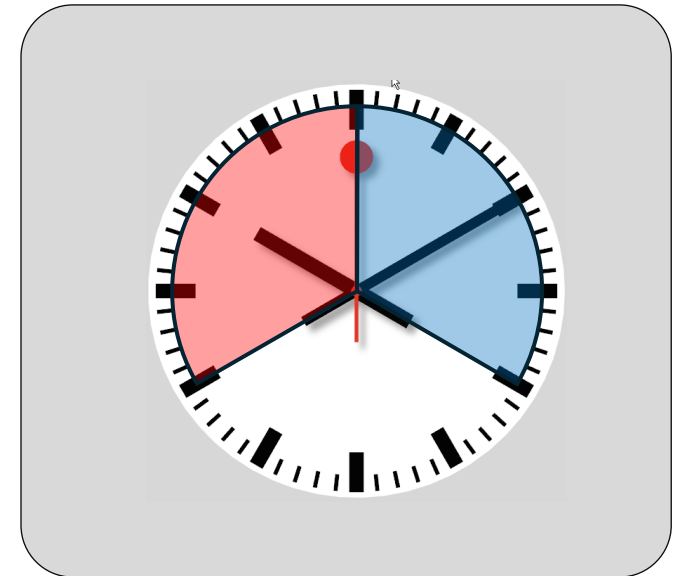

Day Cycle
's ochtends denken
's middags doen

Tools

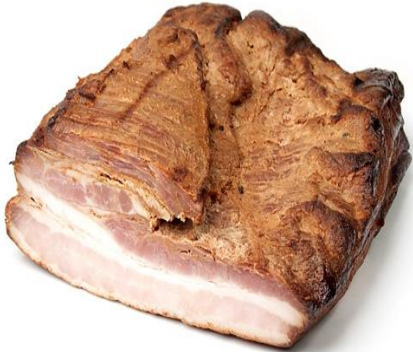

Spec's



Lijst



BOM



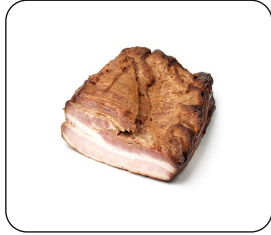

Dromen

Wensen

**Eisen
3-den**



Knutselen voor Professionals

D&E
EVENT

Het ontwerpen van innovatieve elektronica

Woensdag 20 maart 2024
1931 Congressentrum 's-Hertogenbosch

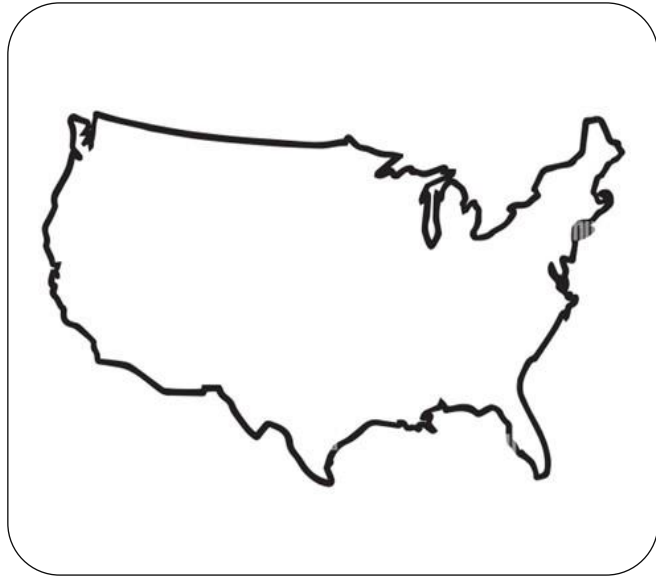
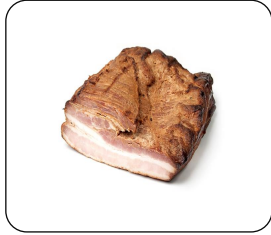

Knutselen voor Professionals



D&E
EVENT
Het ontwerpen van innovatieve elektronica

Woensdag 20 maart 2024
1931 Congressentrum 's-Hertogenbosch

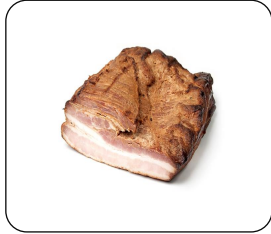

Knutselen voor Professionals

D&E
EVENT

Het ontwerpen van innovatieve elektronica

Woensdag 20 maart 2024
1931 Congressentrum 's-Hertogenbosch

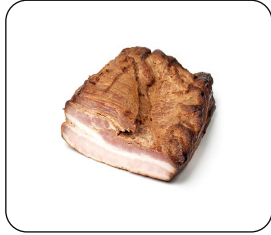

A person who never made a mistake never tried anything new. **Albert Einstein**

An expert is a man who has made all the mistakes which can be made, in a narrow field. **Niels Bohr**

Do not fear mistakes. There are none. **Miles Davis**



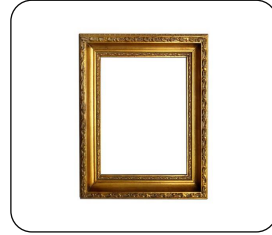

**Lijst met
Vragen**

Prio

Planning



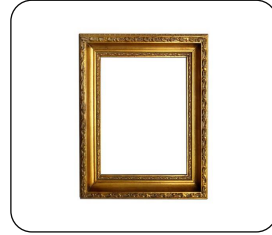

<https://www.epo.org/en/searching-for-patents/technical/espacenet>



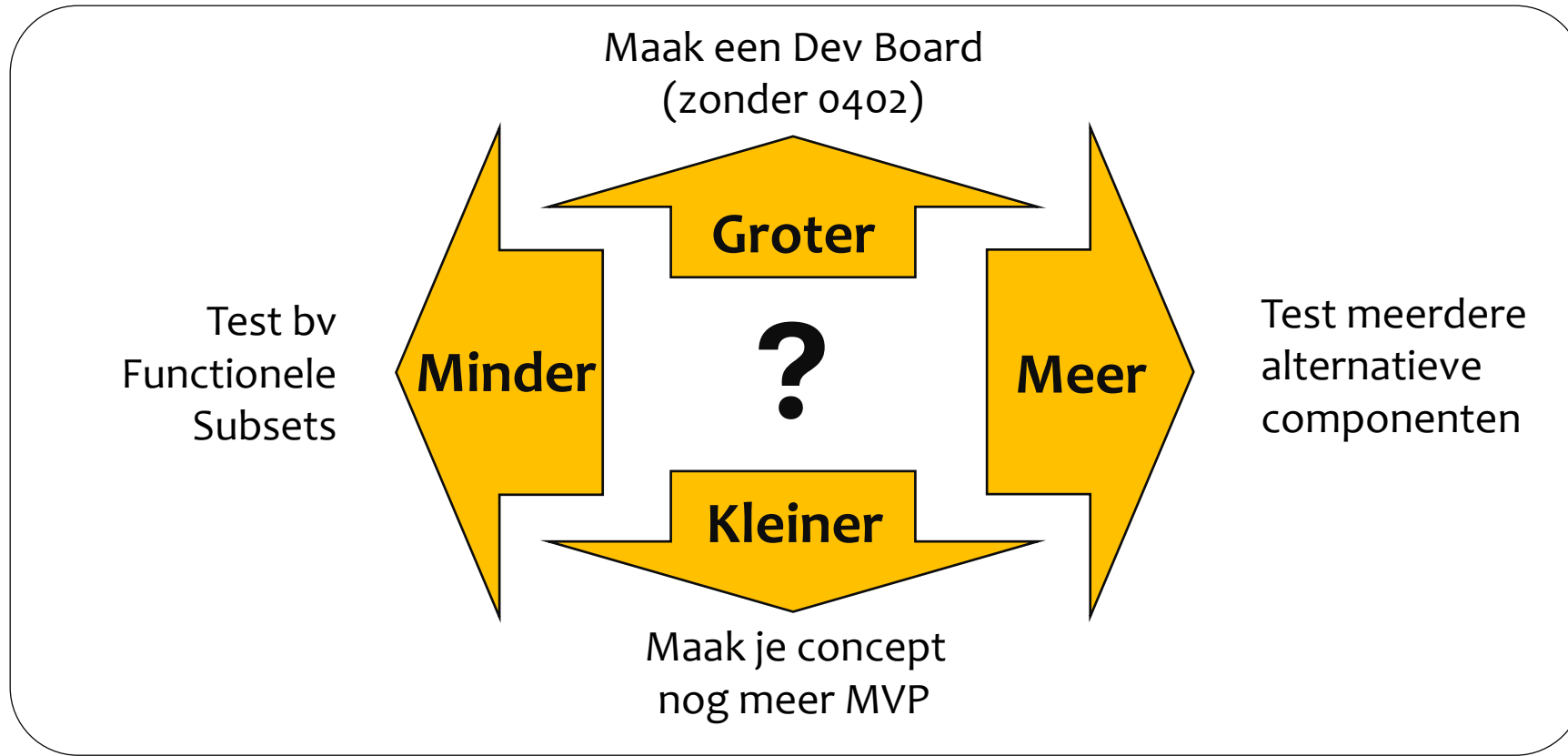
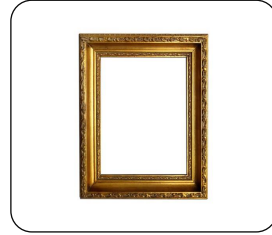



Concept BOM Elevate-F

Sum Pole

Line	Qty	Module	Description	Source	Material	Thickness	Colour	PP/MP	Supplier	Actual	Target Est.	Need	/Unit	Sum Pole
	1	Frame	POLE Assy	4D-Engineers				MP			€ 1.500	1	€ 1.500	
	1	Frame	Belt and Rollers	4D-Engineers				MP			€ 400	1	€ 400	
	1	Frame	Control BOX Assy	4D-Engineers				MP			€ 300	1	€ 300	
	1	Frame	FOOT Assy	4D-Engineers				MP			€ 500	1	€ 500	
	4	Frame	FOOT Corner RUBBERS	4D-Engineers				MP			€ 10	1	€ 40	
	1	Frame	Camera Module Structure	4D-Engineers				MP		€ 500		0	€ -	
	1	Frame	HEAD Assy	4D-Engineers				MP			€ 500	1	€ 500	
	1	Frame	Surface treatment	4D-Engineers				MP			€ 200	1	€ 200	
	1	Frame	Unforseen	4D-Engineers				MP			€ 500	1	€ 500	
			Frame Subtotal										€ 3.940	1 € 3.940



Team



Knutselen voor Professionals

D&E
EVENT
Het ontwerpen van innovatieve elektronica

Woensdag 20 maart 2024
1931 Congressentrum 's-Hertogenbosch

Result



Knutselen voor Professionals

D&E
EVENT
Het ontwerpen van innovatieve elektronica

Woensdag 20 maart 2024
1931 Congressentrum 's-Hertogenbosch



DeltaProto

Maart 2024

Knutselen voor Professionals

Happy Engineering

Michiel Wanninkhof

michiel@deltaproto.com

**D&E
EVENT**

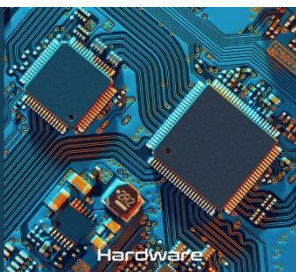

Hardware



Software



Test & Measurement



Engineering



Research & Development

Het ontwerpen van
innovatieve elektronica

Woensdag 20 maart 2024
1931 Congressentrum 's-Hertogenbosch